

*RoHS COMPLIANT



BOURNS®

Features

- Sealed construction (housing sealing according to DIN IEC 68 part 2 - 17 Qc2)
- Additional models and versions available; i.e., locking bushing for locking the shaft
- Cermet resistive element

0620 - Rotary Potentiometer

Characteristics

Mechanical Angle.....285 ° +0 °/-5 °
 Starting Torque.....0.5 to 1.5 Ncm
 End Stop Strength.....40 Ncm max.
 Shaft Push-Pull Force.....50 N max.
 Resistance Range
100 ohms to 1 megohm
 Resistance Curve.....Linear
 Power Rating.....1 W
 Temperature Range.....-55 °C to +125 °C
 Rotational Life.....25,000 cycles

Standard Resistance Table

Resistance (Ohms)	Resistance Code
100	101
220	221
470	471
1,000	102
2,200	222
4,700	472
10,000	103
22,000	223
47,000	473
100,000	104
220,000	224
470,000	474
1,000,000	105

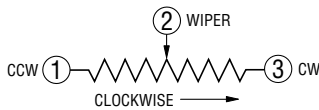

*RoHS Directive 2002/95/EC Jan 27 2003 including AnnexX

Product Dimensions

0620-013

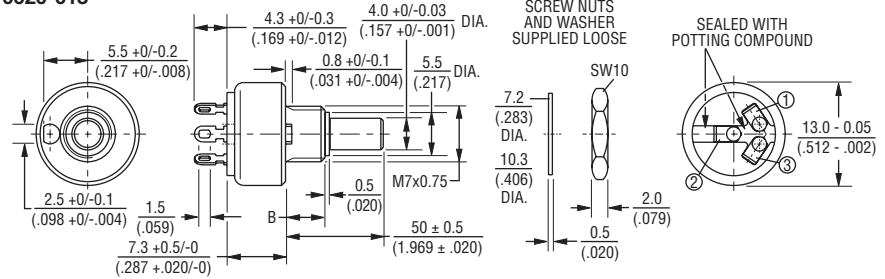

B	5.0 ± 0.05 (.197 ± .002)	8.0 ± 0.05 (.315 ± .002)	12.0 ± 0.05 (.472 ± .002)
---	-----------------------------	-----------------------------	------------------------------

0620-057

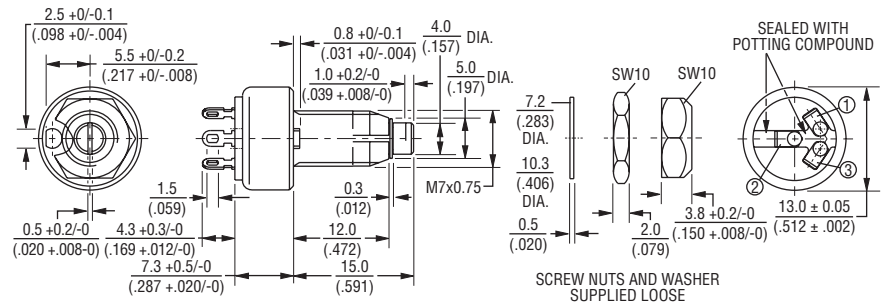

0620-313

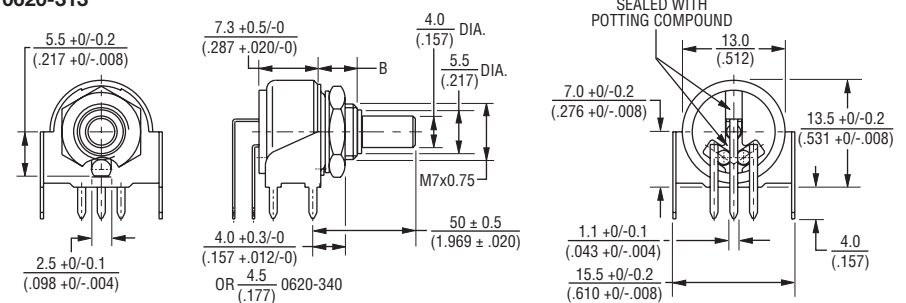

B	8.0 ± 0.05 (.315 ± .002)	12.0 ± 0.05 (.472 ± .002)
---	-----------------------------	------------------------------

DIMENSIONS ARE: $\frac{\text{MM}}{\text{(INCHES)}}$

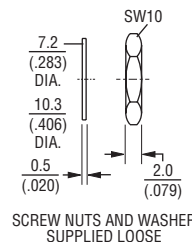

Recommended PCB Layout

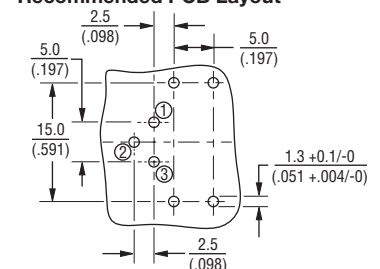

© State Electronics

36 State Route 10, STE 6 • East Hanover, NJ 07936-0436
 973-887-2550 • Toll Free 1-800-631-8083 • Fax 973-887-1940
<http://www.potentiometers.com>

Product Dimensions

0620-613

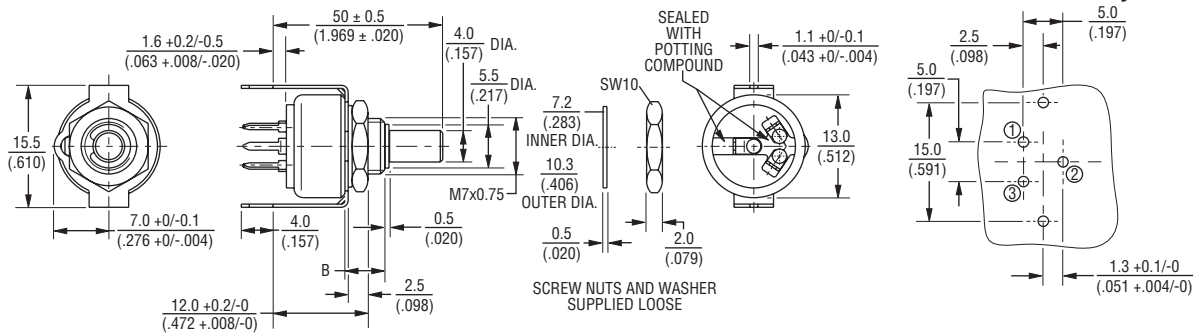

B	8.0 ± 0.05 (.315 ± .002)	12.0 ± 0.05 (.472 ± .002)
---	-----------------------------	------------------------------

How to Order

0620 - 013 U 500 - A B 103

Model Type 0620

Terminal Style 013 (Sealed, available with H & U bushing type only)

057 (Locking bushing, Available with G bushing type only)

313 (Available with H & U bushing types only)

613 (Available with H & U bushing types only)

Other versions available upon request.

Bushing & Shaft Type U = 7 mmD x 8 mmL, Shaft 4 mmD

H = 7 mmD x 5 mmL, Shaft 4 mmD

G = 7 mmD x 12 mmL, Shaft 4 mmD

Shaft Length 500 = 50 mm

Other lengths avail. upon request.

Independent Linearity A = ±5 %

Other versions available upon request.

Element Taper B = Linear Cermet ±20 %

E = Linear Cermet ±10 %

L = Linear Cermet ±5 %

Resistance Code 103

Other versions available upon request.

REV. 01/11

Specifications are subject to change without notice.
Customers should verify actual device performance in their specific applications.

For more information about this product, visit our website at:

www.potentiometers.com